

Evaluation of Drowsiness by HRV Measures - Proposal of prediction method of low arousal state -

Atsuo MURATA and Yasutaka HIRAMATSU

Dept. of Intelligent Mechanical Systems, Division of Industrial Innovation Sciences,
Graduate School of Natural Science and Technology, Okayama University
3-1-1, Tsushimanaka, Kita-ku, Okayama-shi, Japan
E-mail: {murata, hiramatsu}@iims.sys.okayama-u.ac.jp

Abstract— The aim of this study was to propose a useful prediction method of drowsy state of drivers, so that the result is applicable to the development of ITS (Intelligent Transportation System) that can warn drivers of their low arousal state and to prevent driving under low arousal level from occurring. The EEG (electroencephalography) and ECG (electrocardiography) during a monotonous task was measured, and it was investigated how these measures change under the low arousal (drowsy) state. The EEG measurement was added to in order to monitor arousal level more the time series of mean power frequency of EEG was plotted on X-bar control chart. Heart rate variability (HRV) measure RRV3 were derived on the basis of R-R intervals (interbeat intervals) obtained from ECG. Using a Bayesian probability, we tried to predict the timing when the participant actually felt drowsy. As a result, the prediction accuracy differed by the state of participant. When the drowsiness of participant was remarkable, the prediction method was effective to some extent. On the other hand, the proposed method could not predict the drowsy state reliably when the participant did not feel drowsiness to a larger extent.

1. Introduction

Many studies have shown that night work such as driving a truck is associated with increased subjective sleepiness and increased EEG theta (4-7.9Hz) power density. In some cases, drivers actually fell asleep and induce critical and disastrous traffic accidents. Therefore, monitoring drowsiness during driving as an important risk factor for accidents in road transportation has been paid more and more attention. The development of ITS (Intelligent Transportation System) that can monitor drivers' arousal level and warn drivers of a risk of falling asleep and causing a traffic accident is essential for the assurance of safety during driving. However, we have not established effective measures for warning drivers of the risk of causing a traffic accident and preventing it

from occurring. If such a monitoring function of drowsiness is built into ITS and we can warn drivers of a risk of falling asleep in advance, this would contribute to the promotion of safety driving and eventually decreasing disastrous traffic accidents.

Brookhuis et al.^[1] carried out an on-road experiment to assess driver status using psychophysiological measures such as EEG and ECG. They found that changes in psychological parameters such as EEG and ECG reflected changes in driver status and could predict driving impairment that might lead to a disastrous traffic accident. Kecklund et al.^[2] recorded EEG continuously during a night or evening drive for eighteen truck drivers. They showed that during a night drive a significant intra-individual correlation was observed between subjective sleepiness and the EEG alpha burst activity. End-of-the-drive subjective sleepiness and the EEG alpha burst activity were significantly correlated with total work hours. As a result of a regression analysis, total work hours and total break time predicted about 66% of the variance of EEG alpha burst activity during the end of drive. Galley^[3] overcame a few disadvantages of EOG in the measurement of gaze behavior by using on-line computer identification of saccades and additional keyboard masking of relevant gazes by the experimenter. As EOG, especially saccades and blinks, is regarded as one of useful measures to evaluate drivers' drowsiness, such an improvement might be useful to detect the low arousal state of drivers. Wright et al.^[4] investigated sleepiness in aircrew during long-haul flights, and showed that EEG and EOG are potentially promising measures on which to base an alarm system. Skipper^[5] made an attempt to detect drowsiness of driver using discrimination analysis, and showed that the false alarm or miss would occur in such an attempt.

Many studies used psychophysiological measures such as blink, EEG, saccade, and heart rate to assess fatigue^[6-12]. McGregor^[6] suggested caution in interpreting saccade velocity change as an index of fatigue since most of the reduction in average saccade

velocity might be secondary to increase in blink frequency. No measures alone can be used reliably to assess drowsiness, because each has advantages and disadvantages. The results of these studies must be integrated and effectively applied to the prevention of drowsy driving. To prevent drivers from driving under drowsy state and causing a disastrous traffic accident, not the gross tendency of reduced arousal level but more accurate identification of timing when the drowsy state occurs is necessary. It is not until such accurate measures to identify drowsiness and predict the timing of drowsy driving is established that we apply this to the development of ITS which can surely and reliably avoid unsafe and unintentional driving under drowsy and low arousal state.

Although the studies above made an attempt to evaluate drowsiness (or sleepiness) on the basis of psychophysiological measures, Landstrom et. al.^[13] examined the effectiveness of sound exposure as a measure against driver drowsiness. They used twelve lorry drivers in a total of 110 tests of a waking (alarm) sound system. The effectiveness of the waking sound system was verified through subjective ratings by lorry drivers. This system is used by a driver when he or she feels that their arousal level is becoming lower, and there is a risk of falling asleep. The disadvantage of this system is that one must intentionally and spontaneously use the waking alarm system by monitoring their drowsiness by oneself. Eventually, a automobile in future is required to detect the arousal level of a driver automatically by ITS and warn drivers of the drowsy state by using some effective measures such as a waking sound system. Therefore, Murata and Hiramatsu^[15] and Murata and Nishijima^[16] made such an attempt to objectively evaluate the drowsiness of drivers using EEG or HRV measures.

Murata and Hiramatsu^[15] and Murata and Nishijima^[16], by means of the time series data of evaluation measures such as MPF or RRV3, succeeded in clarifying the decrease of MPF or the increase of MPF when the participant's arousal level is low. However, it was not possible to predict the drowsiness on the basis of the time series of MPF or RRV3. These studies merely clarified that evaluation measures such as MPF or RRV3 when the arousal level was high took different values from those when the arousal level was low. Although detecting the arousal level of a driver automatically by ITS and warn drivers of the drowsy state is an ultimate goal in such studies, it is impossible to develop such a system so long as such studies^{[15], [16]} are not further

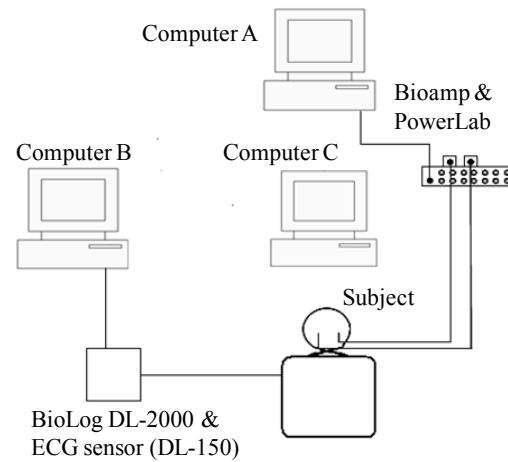

Fig.1 Outline of measurement system.

enhances and the prediction method on the basis of some useful methodology is not established. There are few studies that made an attempt to predict the arousal level systematically on the basis of physiological measures. This research approaches such efforts to predict the drowsy state using Bayesian theory^[17].

The aim of this study was to propose a useful prediction method of drowsy state of drivers. The final and future goal was to apply the results to the development of ITS (Intelligent Transportation System) that can warn drivers of their low arousal state and to prevent driving under low arousal level from occurring. The EEG and ECG during a monotonous task were measured, and it was investigated how these measures change under the low arousal (drowsy) state. The EEG measurement was added to in order to evaluate the arousal level accurately as a baseline. The time series of mean power frequency of EEG was plotted on X-bar control chart. Heart rate variability (HRV) measure RRV3 were derived on the basis of R-R intervals (inter-beat intervals) obtained from ECG. Using a Bayesian probability, an attempt was made to predict the timing when the participant actually felt drowsy.

2. Method

2.1 Participants

Five male graduate or undergraduates (from 21 to 26 years old) participated in the experiment. They were all healthy and had no orthopedic or neurological diseases.

2.2 Apparatus

The outline of experimental (measurement) system is summarized in Figure 1. Electroencephalography (EEG) and Electrocardiography (ECG) activities were acquired

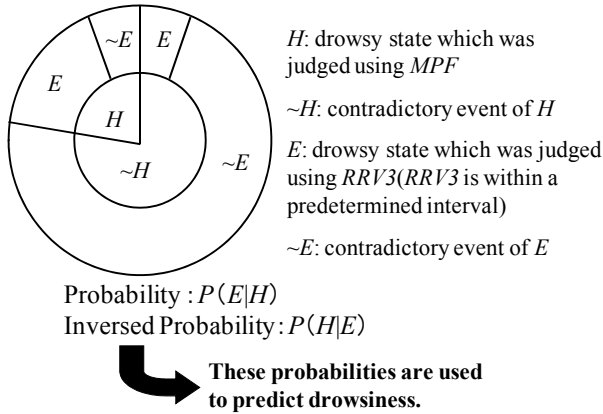

Fig.2 Explanation for calculating inversed probability $P(H|E)$ on the basis of Bayesian theorem.

with measurement equipment shown in Figure1. An A/D instrument PowerLab8/30 and bio-amplifier ML132 were used. Surface EEG was recorded using A/D instrument silver/silver chloride surface electrodes (MLAWBT9), and sampled with a sampling frequency of 1kHz.

2.3 Procedure

According to international 10-20 standard, EEGs were led from O_1 and O_2 . The participants sat on an automobile seat, and were required to watch a driving scene recorded on a highway from the front side. The experimental duration was not predetermined, because the time until the participant became drowsy differed across the participants. Basically, the experiment was continued until the experimenter judged that the participant reached drowsy and low arousal state.

FFT was carried out every 1024 data (1.024s). Before the EEG data were entered into FFT program, the data were passed through a cosine taper window. Based on this, the mean power frequency was calculated. This was plotted as a X-bar control chart as shown in Figure 4. Using a X-bar control chart, the judgment of drowsiness of participants was carried out. The ECG was led from V_5 using BiolaoDL-2000(S&ME).

On the basis of ECG waveform, R-R intervals (inter-beat intervals) were obtained. Heart rate variability (HRV) measure $RRV3$ was derived as follows^[14]. The moving average per ten inter-beta intervals was calculated. Variance of past three inter-beat intervals was calculated as $RRV3$. $RRV3$ is regarded to represent the functions of parasympathetic nervous systems, and the drowsy state leads to the dominance of parasympathetic nervous system. When the parasympathetic system is dominant, it is known that RRV gets larger.

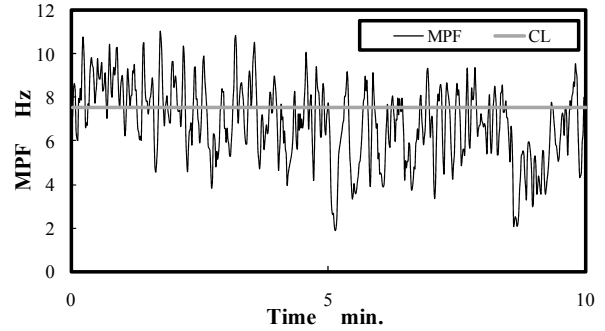

Fig.3: An example of time series of MPF.

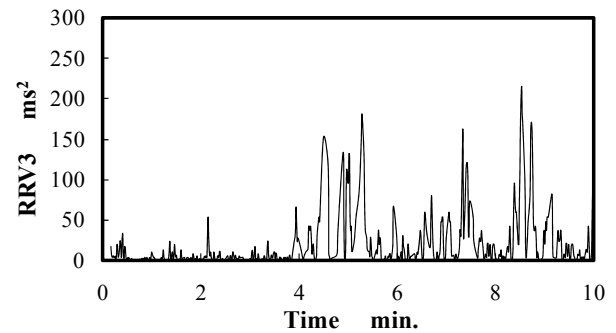

Fig.4: An example of time series of RRV.

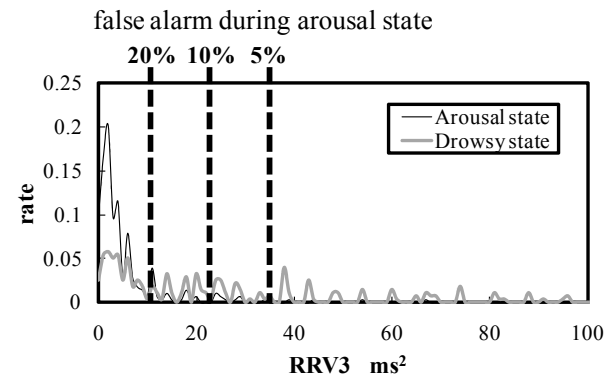

Fig.5: An example of frequency distribution of $RRV3$ for H and $\sim H$

3. Prediction of low arousal state by Bayesian Probability^[16]

In this section, the prediction of drowsiness on the basis of Bayesian probability is briefly mentioned. First, the following event is defined.

H : drowsy state which was judged using MPF .

$\sim H$: contradictory event of H .

E : drowsy state which was judged using $RRV3$ ($RRV3$ is within a predetermined interval).

$\sim E$: contradictory event of E .

The following conditional probability is also defined.

$P(E|H)$: the probability of E when the state judged by MPF is drowsy.

$P(H|E)$: the probability of drowsy state judged by MPF

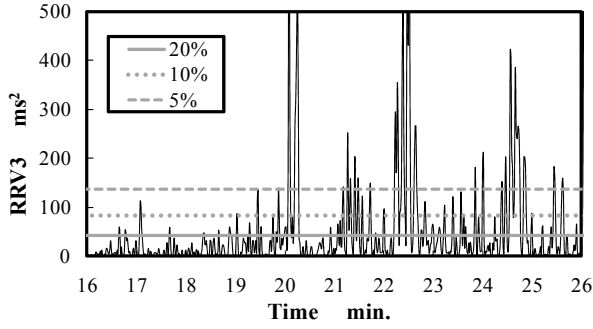

Fig.6: Threshold setting for calculating $P(E|H)$ and $P(H|E)$ and Judgment of drowsiness using RRV3.

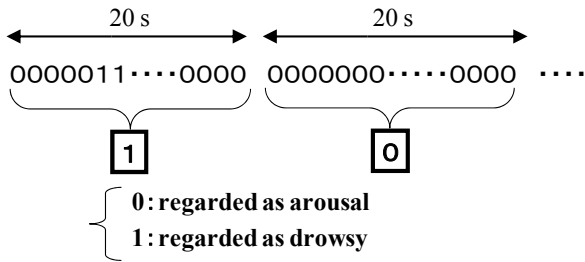

Fig.7: Adjustment of time lag between EEG and RRV3.

(H) when E is true.

$P(H)$: the probability of H (drowsy state judged by MPF).

$P(\sim H)$: the probability of $\sim H$ (non-drowsy state judged by MPF).

In the Bayesian probability theory, the inversed probability $P(Z|Y)$ is calculated on the basis of the conditional probability $P(Y|Z)$. Here, Y and Z denote arbitrary events.

The inversed probability $P(H|E)$ can be calculated using the following Bayesian theorem.

$$P(H|E) = \frac{P(H)P(E|H)}{P(H)P(E|H) + P(\tilde{H})P(E|\tilde{H})} \quad (1)$$

This formula is schematically depicted in Fig.2. This schematic diagram is more useful and intuitive to understand Bayesian theorem than Eq.(1) above. In such a way, an attempt was made to predict the drowsy state.

4. Results

An example of the time series of MPF (Mean Power Frequency) of EEG^[15] is shown in Fig.3. The time series of RRV3^[14] is shown in Fig.4. The higher RRV3 is, the

		Threshold					
		20%	30%	40%	50%	60%	70%
False alarm	20%				0.655	0.504	0.317
	10%			0.586	0.485	0.352	
	5%			0.328	0.343	0.233	
			0.769	0.586	0.426		
		0.383	0.367	0.284			

$P(E|H)$ H : drowsy state which was judged using MPF.
 $P(H|E)$ E : drowsy state which was judged using RRV3(RRV3 is within a predetermined interval).

Table 1: $P(E|H)$ and $P(H|E)$ as a function of false alarm and threshold value

		Threshold					
		20%	30%	40%	50%	60%	70%
False alarm	20%				0.273	0.182	0
	10%			0.227	0.136	0	
	5%			0.556	0.6	0	
			0.545	0.227	0.045		
		0.706	0.714	0.333			

$P(E|H)$ H : drowsy state which was judged using MPF.
 $P(H|E)$ E : drowsy state which was judged using RRV3(RRV3 is within a predetermined interval).

Table 2(a): $P(E|H)$ and $P(H|E)$ as a function of false alarm and threshold value for participant A

		Threshold					
		20%	30%	40%	50%	60%	70%
False alarm	20%				0.793	0.586	0.276
	10%				0.18	0.173	0.125
				0.828	0.586	0.279	
	5%			0.194	0.183	0.125	
		0.966	0.828	0.586			
		0.194	0.185	0.172			

$P(E|H)$ H : drowsy state which was judged using MPF.
 $P(H|E)$ E : drowsy state which was judged using RRV3(RRV3 is within a predetermined interval).

Table 2(b): $P(E|H)$ and $P(H|E)$ as a function of false alarm and threshold value for participant B

lower the arousal level is.

According to Fig.5 and Fig.6, the drowsiness was judged on the basis of RRV3 as a reference of the evaluation results of drowsiness on the basis of EEG time series. Fig.5 is the frequency distribution of RRV3 for high arousal and drowsy states. As shown in Fig.5,

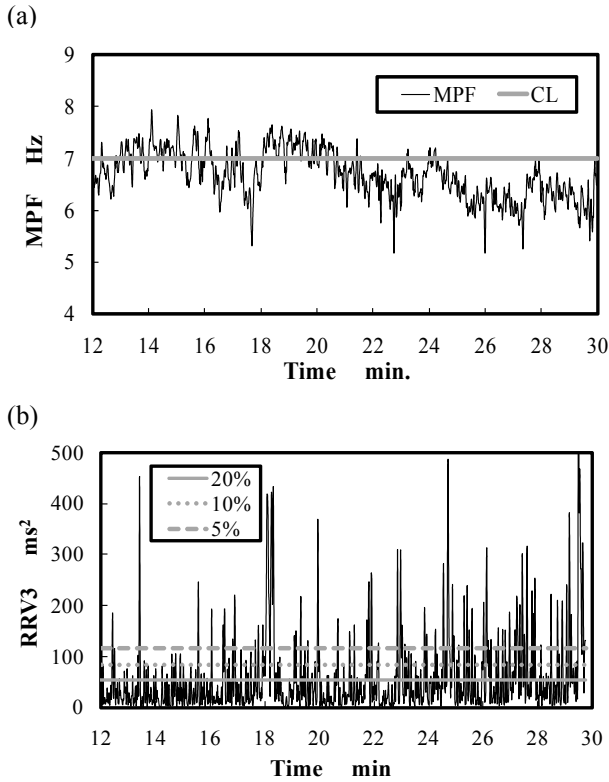

Fig.8: Time series of MPF and RRV3 for participant A ((a) MPF, (b) RRV3).

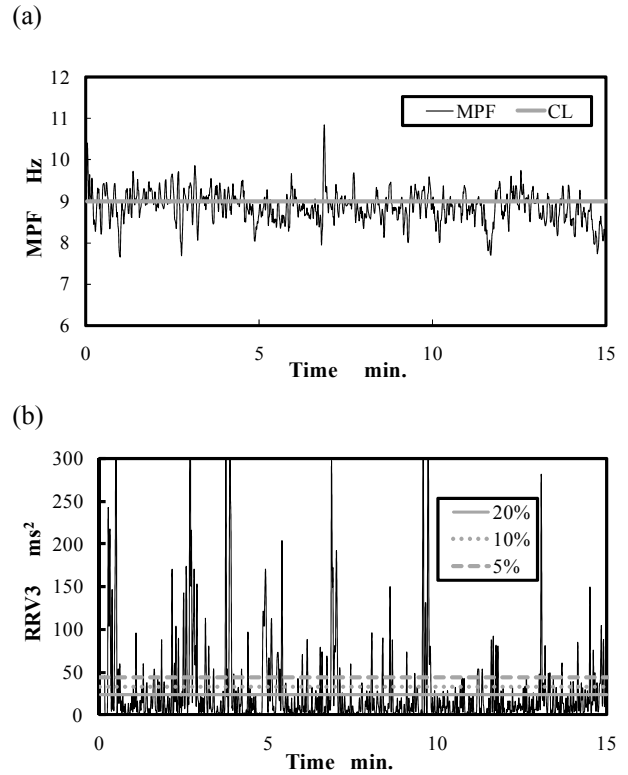

Fig.9: Time series of MPF and RRV3 for participant B ((a) MPF, (b) RRV3).

three kinds of thresholds were set so that the values of false alarm when the participant was perfectly arousal (awake or vivid) are 20%, 10%, and 5%, respectively. False alarm means that the system predicts the drowsiness of the participant in spite of the participant not feeling drowsiness. Hit rate for each value of threshold was obtained. Hit means that system predict the drowsiness when the participant actually feels drowsy. As shown in Fig.6, the drowsiness by means of RRV3 was carried out as follows. The following three kinds of thresholds (percentage of data which is above CL (Central Line: mean value in Fig.6)) were set to each of false alarm above (5%, 10%, and 20%): 20, 30, and 40% for false alarm of 5%, 40, 50, and 60% for false alarm of 10%, 50, 60, and 70% for false alarm of 20%. The adjustment of time lag between EEG and RRV3 was carried out as follows (See Fig.7). When the decrease of arousal level was observed at least one time in 20 s, we regarded this as a drowsy state. When the decrease of arousal level was not observed at all in 20 s, we regarded this as a waken state.

The results of calculation of $P(E|H)$ and $P(H|E)$ are

summarized in Table 1 and Table 2(a) and (b). Table 1 corresponds to the mean value of five participants. The inverted probability $P(H|E)$ ranged from about 0.2 to 0.7, and differed significantly among participants. Table 2(a) summarizes a result of participant A with higher inverted probability $P(H|E)$. Table 2(b) corresponds to a result of participant B with lower inverted probability $P(H|E)$. The time series of MPF^[15] and RRV3^[14] corresponding to participant A are plotted in Fig.8(a) and (b), respectively. Similar result corresponding to participant B is plotted in Fig.9(a) and (b), respectively.

5. Discussion

As shown in Table 1, $P(E|H)$ and $P(H|E)$ tended to be higher when thresholds (percentage of data which is above CL (Central Line: mean value in Fig.6)) was set to a small value. This tendency can also be confirmed in Table 2(a) and (b). The threshold of 20% means that it was regarded as drowsy when 20% of RRV3 data is above CL. For each false alarm, $P(E|H)$ and $P(H|E)$ tended to increase with the decrease of threshold value.

There was much dispersion of $P(E|H)$ and $P(H|E)$ among participants. This is discussed in more detail. Table 2(a) corresponds to the data of participant A who is becoming drowsy with time as shown in Fig.8(a) and (b). Table 2(b) corresponds to the data of participant B who is not becoming so drowsy like participant A as shown in Fig.9(a) and (b). This must mean that the degree or level of drowsiness have some effects on the prediction accuracy. When the arousal level is within the phase where the arousal level is steadily decreasing, the proposed method might be promising. However, it is possible that the arousal level drops abruptly. Although the prediction of such an abrupt change is of course important, the present research has a limitation that it cannot deal with such an abrupt change. Future research should be carried out to deal with such an abrupt change. Classifying the phase where the arousal level is changing, and predicting the arousal level according to the classified phase in some way might be a promising means.

In this study, $P(E|H)$ and $P(H|E)$ were not calculated continuously. Therefore, future research should make an attempt to monitor $P(E|H)$ and $P(H|E)$ continuously, and provide drivers with some warning on the basis of continuous calculation of these probabilities. Recording the history of change of $P(E|H)$ and $P(H|E)$ for each driver might further enhance the prediction ability.

A method to predict drowsiness on the basis of RRVS using Bayesian theorem had been proposed. The prediction accuracy was found to differ by the depth or strength of drowsiness. When the drowsiness was induced to a larger extent, the prediction accuracy of the proposed method was satisfactory to some extent. When the drowsiness was not severely induced, we could not attain satisfactory prediction accuracy. Therefore, at present, it is still not possible to predict the arousal level accurately and on the basis of the values of HRV measures. Future research should improve the accuracy of prediction even when the drowsiness was not induced so severely.

References

- [1] Brookhuis, K.A. and Waard, D., The use of psychophysiology to assess driver status, *Ergonomics*, 36, 1099-1110, 1993.
- [2] Kecklund, G. and Akersted, T., Sleepiness in long distance truck driving: An ambulatory EEG study of night driving, *Ergonomics*, 36, 1007-1017, 1993.
- [3] Galley, N., The evaluation of the electrooculogram as a psychophysiological measuring instrument in the driver study of driver behavior, *Ergonomics*, 36, 1063-1070, 1993.
- [4] Wright, N. and McGown, A., Vigilance on the civil flight deck: incidence of sleepiness and sleep during long-haul flights and associated changes in physiological parameters, *Ergonomics*, 44, 82-106, 2001.
- [5] Skipper, J.H. and Wierwillie, W., Drowsy driver detection using discrimination analysis, *Human Factors*, 28, 527-540, 1986.
- [6] McGregor, D.K. and Stern, J.A., Time on task and blink effects on saccade duration, *Ergonomics*, 39, 649-660, 1996.
- [7] Fukui, T. and Morioka, T., The blink method as an assessment of fatigue, *Ergonomics*, 14, 23-30, 1971.
- [8] Piccoli, B., D'orso, M., Zambelli, P.L., Troiano, P., and Assint, R., Observation distance and blinking rate measurement during on-site investigation: new electronic equipment, *Ergonomics*, 44, 668-676, 2001.
- [9] Sharma, S., Linear temporal characteristics of heart interbeat interval as an index of the pilot's perceived risk, *Ergonomics*, 49, 874-884, 2006.
- [10] Tejero, P. and Choliz, M., Driving on the motorway: the effect of alternating speed on driver's activation level and mental effort, *Ergonomics*, 45, 605-618, 2002.
- [11] Milosevic, S., Vigilance performance and amplitude of EEG activity, *Ergonomics*, 21, 887-894, 1978.
- [12] Fumio, Y., Frontal midline theta rhythm and eyeblinking activity during a VDT task and a video game; useful tools for psychophysiology in ergonomics, *Ergonomics*, 41, 678-688, 1998.
- [13] Landstrom, U., Englund, K., Nordstrom, B., and Astrom, A., Sound exposure as a measure against driver drowsiness, *Ergonomics*, 42, 927-937, 1999.
- [14] Murata, A. and Hiramatsu, Y., Evaluation of Drowsiness by HRV Measures- Basic Study for Drowsy Driver Detection -, *Proc. of IWCIA2008*, 99-102, 2008.
- [15] Murata, A. and Nishijima, K. Y., Evaluation of Drowsiness by EEG analysis -Basic Study on ITS Development for the Prevention of Drowsy Driving-, *Proc. of IWCIA2008*, 95-98, 2008.
- [16] Hershman, R.L., A rule for the integration of Bayesian options, *Human Factors*, 13(3), 255-259, 1971.