

## *Estimation of Loosening of Knee Joint Prosthesis*

Hisao OKA\* and Masakazu OHSHIMA\*

(Received February 25, 1997)

### SYNOPSIS

Knee replacement arthroplasty is indicated for the patient with advanced knee pain, knee deformation, and knee functional disorder. The aim of this study was to estimate loosening after a knee replacement arthroplasty. Loosening is measured by a frequency response function, and mobility by random vibration. The modal parameters for the knee joint are obtained by applying a modal analysis to the frequency response function. The values decrease as the knee joint prosthesis loosened. These parameters serve as an index for the condition between a thighbone and the prosthesis. The various indexes will greatly clarify the stage of advance in the loosening of knee-joint prostheses.

### 1. INTRODUCTION

Knee replacement arthroplasty is indicated for the patient with advanced knee pain, knee deformation, and knee functional disorder. Unfortunately, the performance of the prosthesis cannot exceed that of the natural joint<sup>(1)</sup>. When the rate of prosthesis dislocation increases, as it inevitably will, it is critical that an orthopedist diagnose the problem quickly and accurately. Loosening of the knee-joint prosthesis is currently diagnosed subjectively and experientially by means of radiography, arthrography, and manual palpation. If this evaluation could be made objective and quantitative, not only would the diagnosis be more accurate but the progression of the loosening would be easier to track. Thus, in this study, a vibration technique normally used to quantify the loosening of hip-bone prostheses is applied to the *in vivo* evaluation of knee-joint prostheses<sup>(2,3)</sup>. Loosening is measured by a frequency response function, and mobility by random vibration. The modal parameters for the knee joint--i.e., modal stiffness, modal mass, and damping ratio--are obtained by applying a modal analysis to the frequency response function. The physical characteristics between prosthesis and thighbone can then be described using these parameters and the resonance frequency. Taken together, the various indexes will greatly clarify the stage of advance in the loosening of knee-joint prostheses.

---

\* Department of Electrical & Electronic Engineering

## 2. MEASUREMENT SYSTEM

Loosening of the knee joint prosthesis is estimated by calculating mechanical mobility with a random signal. A diagram of the measurement system used in this study is shown in Fig. 1. This system consist of a measuring probe, oscillator, amplifier and personal computer. The measuring probe is composed of a vibrator, a load cell, a impedance head and a vibrating tip<sup>(4)</sup>.

The random vibration, which is restricted from 30 to 1000Hz, is applied on a part of the knee joint vertically through the vibrating tip, is driven by the vibrator. And an acceleration  $a(t)$  and force  $f(t)$  response at the driving point are detected by a measuring probe. These values are then entered into a personal computer and sampled with an A/D converter at 3kHz and 512 points. Then these data are calculated by means of the FFT. The full process is repeated sixteen times and the results averaged. The mobility is calculated as follows:

$$H(f) = \frac{V(f)}{F(f)} = \frac{A(f) / j\omega}{F(f)} = \frac{A(f)}{j\omega F(f)} \quad \dots(1)$$

$F(f)$  and  $A(f)$  show Fourier Transform of  $f(t)$  and  $a(t)$ , respectively. And these are measured only when the contact pressure which is detected by the load cell is within an initial set range. In this paper, unless otherwise specified, the contact pressure was set in the range of  $150 \pm 5$ gf.

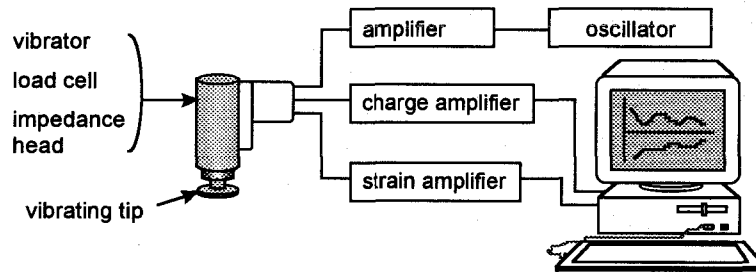

Fig. 1 Diagram of measurement system.

## 3. FEMORAL MODEL

The femoral model which is used in this study is composed of a zimmer-type knee joint prosthesis (Zimmer Japan, femoral component 5972-14-03), a thighbone model, and a silicone-rubber impression material which is used for fastening. The size of the femoral model, which is composed of the prosthesis and thighbone model, is shown in Fig. 2.

A loose-jointed model was made with these materials. When the mobility of the femoral model was measured, a silicone-gel was put on it. The loosening of the knee joint prosthesis was measured by pressing the measuring probe vertically. The silicone-gel substitute for skin has a thickness of five mm. Three kinds of stiff silicone-gels were used. The gel having a stiffness about like that of tendon was designated silicone-gel A, while silicone-gels B and C were those having more or less stiffness than tendon, respectively. Loosening of the knee joint prosthesis was measured and

estimated with these materials.

At first measurement, the femoral model was fastened hard to the vise which was fixed on the table. Then the thighbone model was shaved little by little, and the loosening between the thighbone model and knee joint prosthesis was increased. The resonance appeared in each mobility spectra, and the natural frequency moved to lower frequency regions. According to this result, moving of the natural frequency could be an index of loosening.

Next for the measurement *in vivo*, the femoral model was fastened to a table as shown in Fig. 3. The expanded polystyrene representing the muscle was bound around the thighbone model, and the femoral model was fastened with weights of roughly the same weight of the corresponding femoral muscle. The following measurements were made using this model.

#### 4. EXAMINATION OF MEASURING CONDITIONS

Because the particular method of measuring prosthesis loosening may itself change the mobility, we next examined the effects of various measurement techniques on mobility. There are shown in Fig. 4. The measuring conditions are contact pressure, vibrating amplitude, and vibration tip diameter in the measurement system, and measuring point, silicone-gel stiffness, and fastening in the femoral model. The mobility change was particularly found in a resonance frequency.

The mobility spectra were not noticeably affected by changes in vibration amplitude, vibration tip diameter, or measuring point. As the contact pressure and silicone-gel stiffness were varied, the resonance frequency was clearly changed in case of large contact pressure and soft silicone-gel. These results not only influence the stiffness of skin, but the thickness. The thicker the skin becomes, the more significant its influence. This effect will be hard to recognized in a resonance frequency. For this reason it is good to estimate loosening under large contact pressure. If the pressure is too large, however, the patient experiences pain and displeasure.

The position of the weights was changed. But the condition of loosening of the knee joint

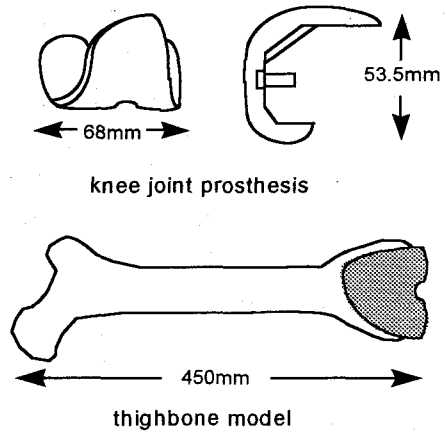

Fig. 2 Femoral model.

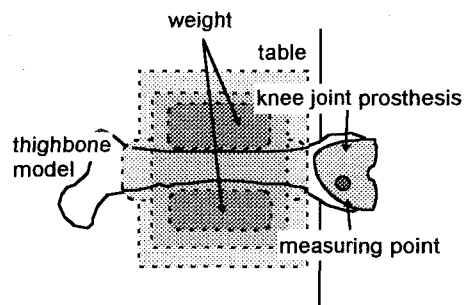

Fig. 3 Fastening of femoral model.

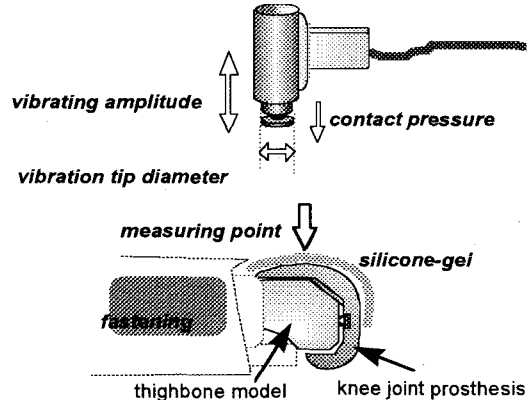

Fig. 4 Measuring conditions.

prosthesis remained. The effects of weight position are shown in Fig. 5(a) and (b). This figure shows the mobility spectrum shifting when the position of the weights change. Two or three resonances were recognized from 200 to 1000Hz in the mobility spectrum when this femoral model was measured. The resonance frequency between states 1 and 2 around 600Hz is the same. In the frequency around 200-400Hz, however, the resonance frequencies are quite different. When the weight position changes, the resonance frequency increases/decreases or disappears. For this reason the natural frequency, which is the range from 500 to 600Hz, shows loosening of the knee joint prosthesis in this model.

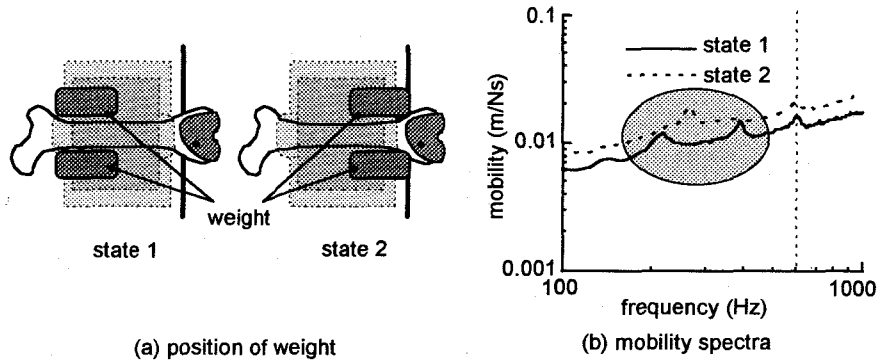

Fig.5 Mobility spectra at different measuring points.

5. ESTIMATION OF LOOSENING

5.1 Modal Analysis

The modal analysis deal with a vibration in a mix of natural models, which include a mass, a stiffness and a damping coefficient. The experimental data on vibration response are analyzed, and dynamic characteristics are revealed. There are a natural frequency, a natural mode, and a damping coefficient<sup>(6)</sup>.

Figure 6 shows a physical model of one degree of freedom system. When an exciting force, whose amplitude is  $F$  and angular frequency is  $\omega$ , is put on it, the equation of force equilibrium is as follows:

$$m\ddot{x} + c\dot{x} + kx = Fe^{j\omega t} \quad \dots(2)$$

where  $m$  is a mass,  $c$  is a damping coefficient, and  $k$  is a stiffness.

Setting  $x$  as  $x = Xe^{j\omega t}$ , and using the following equations,

$$m/k = 1/\Omega^2 \text{ and } c/k = 2\zeta \frac{1}{\Omega} = 2 \frac{c}{c_c} \frac{1}{\Omega} \quad \dots(3)$$

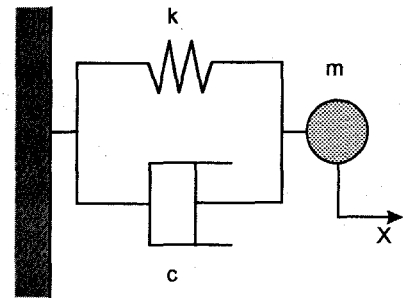

Fig. 6 Physical model of single freedom of degree.

the frequency response function for the mobility  $H(\omega)$  is given by

$$H(\omega) = \frac{j\omega X(\omega)}{F(\omega)} = \frac{j\omega/k}{1 - \beta^2 + 2j\zeta\beta} = \frac{j\Omega\beta/k}{1 - \beta^2 + 2j\zeta\beta} \quad \text{with } \beta = \omega/\Omega \quad \dots(4)$$

where  $\Omega$  is the undamped natural angular frequency,  $\zeta$  is damping ratio and  $c_c$  is critical damping coefficient. We can calculate this function with a vibration test, and then we obtain a modal parameters, which are  $\Omega$ ,  $\zeta$  and  $k$ . The resonance frequency of the mobility is irrelevant to

a damping and constant.

The actual construction is a continuum or multiple degree of freedom system, so the equation 4 needs to extend to N degree of freedom system. But a natural mode around a natural frequency on multiple degree of freedom system is regarded as that of single degree of freedom system. The modal parameters of the natural mode can be determined separately. The equation for a natural mode of multiple degree of freedom is expressed as the equation 6 around a natural frequency. The mobility of single degree of freedom system expresses a circle approximately on Nyquist plot. The mobility of multiple degree of freedom system becomes a circle around each resonance points in a similar way. The equation 4 completely disregard an influence of the other natural modes. In this method, it is regarded as the complex constant  $R + jI$ . This complex constant  $R + jI$  shifts a center of circle to  $R$  in real axis and to  $I$  in imaginary axis. Real part and imaginary part of the mobility  $H$  are expressed as  $H_R$  and  $H_I$  respectively, and the following equation is obtained.

$$\left\{ H_R - \left( \frac{\Omega}{4k\zeta} + R \right) \right\}^2 + (H_I - I)^2 = \left( \frac{\Omega}{4k\zeta} \right)^2 \quad \dots(5)$$

The measured data of around resonance point is curve-fitted by a circle equation, and the modal parameters are obtained by the equation 5.

### 5.2 Estimation of Loosening of Femoral Model

In the experimental model, three kinds of silicone-rubber impression material with a different stiffness are inserted between the thighbone model and the knee joint prosthesis. The silicone-rubber impression material is used for a dental impression material. Three kind of stiff one were arranged for it. The stiffest one is named XANTOPREN® grün plus(Bayer Dental Co. Ltd.), the softest one is named XANTOPREN® plus(Bayer Dental Co. Ltd.) and the other is named G-C's Flexicon(G-C Dental Industrial Corp.). The values of stiffness by means of a durometer of JIS(Japanese Industrial Standard) are 53,49 and 33, respectively. The larger the value, the stiffer the silicone-rubber impression material. The measured results are shown in Fig. 7. Fig. 7(b) shows

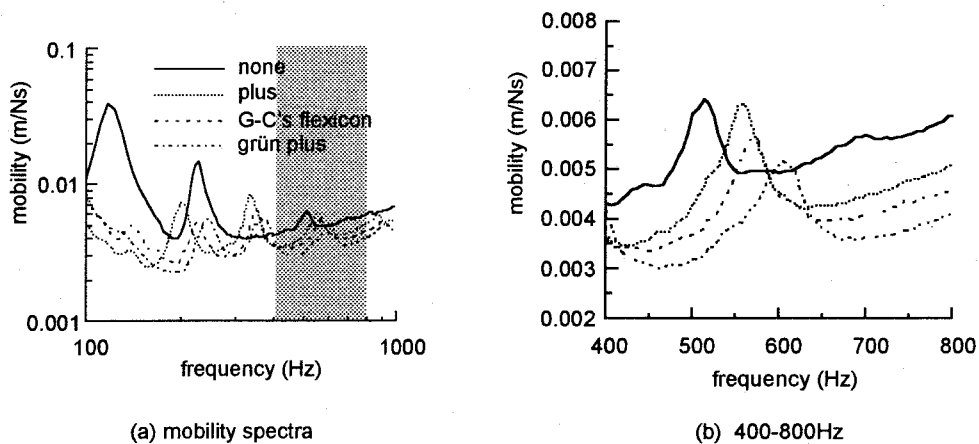

Fig. 7 Mobility spectra at different weight position.

that a part of resonance is enlarged around 600Hz.

This figure shows the natural frequency of the mobility shifted due to the stiffness of the silicone-rubber impression material. When the silicone-rubber impression material is not inserted between the thighbone and the prosthesis, the natural frequency is the lowest. the model which is inserted none is only insert the prosthesis to the shaved thighbone model.

Next, the modal analysis was applied to the mobility. Table 1 shows the modal parameters obtained by means of the circle curve fitting method. The softer the silicone-rubber impression material, the more loose the prosthesis, and the smaller the values of the natural frequency, the stiffness, and the damping ratio. In the absence of silicone-rubber impression material, the damping ratio increases. The reason for this is that the condition of fastening of the prosthesis is essentially different from one of silicone-gel. It is considered that the natural frequency  $f_0$  and the stiffness  $k$  show a loose stage, and the damping ratio  $\zeta$  shows a condition of loosening. The modal mass does not express the mass of itself. It may be equivalency mass. The prosthesis is 0.236kg in weight. Then these parameters will become an index to estimate loosening of the knee joint prosthesis.

Table 1 Circle curve fitting method

impression materials	none	plus	G-C's flexicon	grün plus
modal parameters				
natural frequency $f_0$ (Hz)	506	554	577	606
damping ratio $\zeta$	0.0499	0.0361	0.0408	0.0424
stiffness $k$ (kg/s <sup>2</sup> )	$2.22 \times 10^7$	$2.29 \times 10^7$	$2.48 \times 10^7$	$2.79 \times 10^7$
mass $m$ (kg)	2.20	1.89	1.88	1.93

## 6. APPLICATION TO CLINIC

### 6.1 Loosening of Prosthesis

A pair of femoral and tibial components is inserted to the patient. In measuring with a model an object is only the femoral component, but in fact the tibial component brings about loosening earlier than it. For this reason, the measurement of tibial-component loosening is important. The mobility of the femoral component is measured when the patient is seated on a chair with his or her legs dangling. The tibial component is measured with the feet kept on the ground, because the tibia is not fastened in such method.

The measuring points are shown in Fig. 8. The measurement is made three times at one measuring point. The three patients (A, B and C) were diagnosed by the orthopedist and did not have a loosening of prosthesis. Table 2 shows a case history sheets of three patients. The measured results are shown in the appendix. The knee joint prosthesis is not inserted to the left leg of the patient B but she has an attack of rheumatism. The difference between the mobility

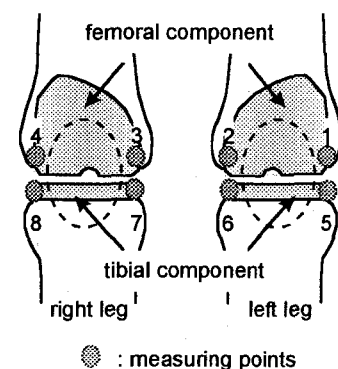

Fig. 8 Measuring points on clinical trial.

Table 2 Case history sheets of three patients.

patient	sex	age	operation date		type of prosthesis		fastening of femoral component		fastening of tibial component	
			right	left	right	left	right	left	right	left
A	male	54	Feb. 1985	Mar. 1985	constrained	anatomic	cement	cement	cement	cement
B	female	66	Feb. 1996	/	anatomic	/	self-locking	/	screw	/
C	female	61	Sep. 1992	Dec. 1987	anatomic	anatomic	self-locking	self-locking	screw	cement

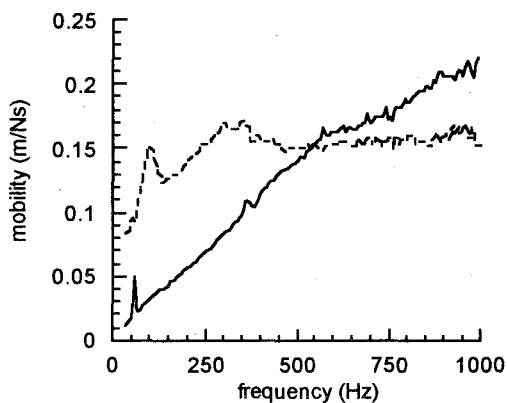

Fig. 9 Mobility spectra of a natural knee joint and an artificial knee joint.

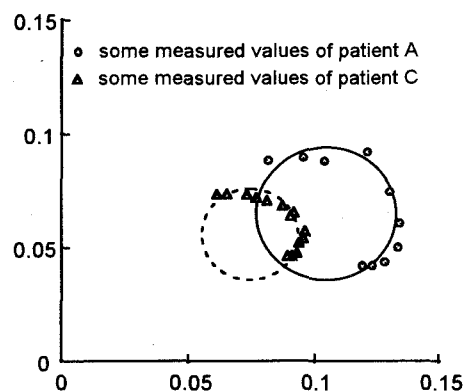

Fig. 10 Modal analysis by circle curve fitting method.

spectrum of a natural knee joint and that of the artificial knee joint is shown in Fig. 9.

The circle curve fitting was applied to the mobility spectra which were measured on measuring point 2 of the patient A and measuring point 6 of the patient C. Figure 10 shows the result which was curve-fitted for a natural mode around 200Hz. The modal parameters which were obtained in

such way are shown in Table 3. In connection with the natural frequency  $f_0$  and the stiffness  $k$ , the patient A is smaller than the patient C. Both these prosthesis are fastened with a cement and in connection with the damping ratio  $\zeta$  A is smaller than C, too. Then a loosening of the knee joint prosthesis could be considered as the patient A is looser.

Table 3 Modal parameters in case of circle curve fitting method was applied to the patients.

	patient A	patient C
natural frequency $f_0$ (Hz)	105	176
damping ratio $\zeta$	0.211	0.274
stiffness $k$ (kg/s <sup>2</sup> )	$271 \times 10^2$	$530 \times 10^2$
mass $m$ (kg)	0.0618	0.0435

### 6.2 Discussion

In this study, three patients were measured. None of the three showed prosthesis is loosening by X-ray or palpation. But a characteristic change appeared in some mobility spectra, at around 200Hz.

This change could be found a lot in the case of the tibial component. In measuring of the femoral model, it appeared around 600Hz, but in clinical trials it was around 200Hz. When the resonance did not appear, it is considered that a prosthesis is fixed completely on a thighbone, it disappeared owing to influence of the covered skin or the selection of measuring point is missed.

In the experiment of the model in which the silicone-rubber impression material is inserted, there is not a rickety condition, however, the resonance appeared. So a little loosening could be found. It is expected that a significant sign for loosening appears around 200Hz on clinical trials. But it needs to be compared with the late loosening as the clinical data is not enough in this time.

## 7. CONCLUSIONS

The aim of this study was to estimate loosening after a knee replacement arthroplasty. Prosthesis loosening was measured and estimated by means of the mobility with random vibration. The loosening was estimated easily by a movement of a natural frequency. It shifted to the lower frequency region with loosening. In addition, modal analysis was applied to a natural mode, and modal parameters for estimation of loosening were calculated. The values decrease as the knee joint prosthesis loosened. These parameters serve as an index for the condition between a thighbone and the prosthesis. When the loosening of the patient's prosthesis is measured, the fastening of femur and the influence of skin covering should also be considered.

### *Acknowledgments*

We would like to thank Dr. Mitsuo Suzuki of Murayama National Hospital for suggesting this problem and for stimulating interest in it.

## REFERENCES

- (1) S. Niwa, M. Yamamoto: "Knee of Surgery", Kinbara Co. (1989), 395.
- (2) P. L. S. Li, N. B. Jones & P. J. Gregg: British Editorial Society of Bone and Joint Surgery, 77-B, 4 (1995), 640.
- (3) W. H. Chang & C. W. Wang: Pro. 15th. Int. Conf. IEEE in Med. And Biol. Soc. (1993), 1103.
- (4) H. Oka, T. Yamamoto & Y. Okumura: Innov. Tech. Biol. Med., 8, (1987), 1.
- (5) A. Nagamatsu: "Introduction to Modal Analysis", Corona Co. (1993), 339.



**Appendix : Mobility spectra of clinical trials**

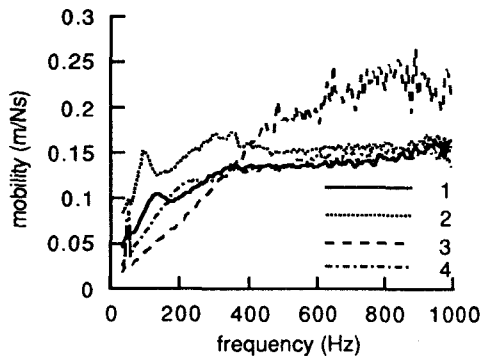

(a) femoral component

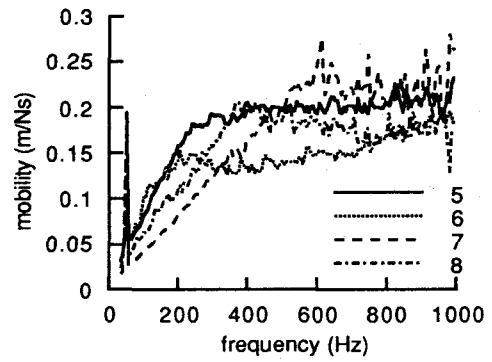

(b) tibial component

(1) mobility spectra of patient A

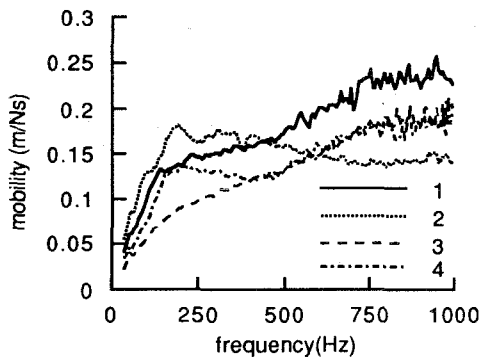

(a) femoral component

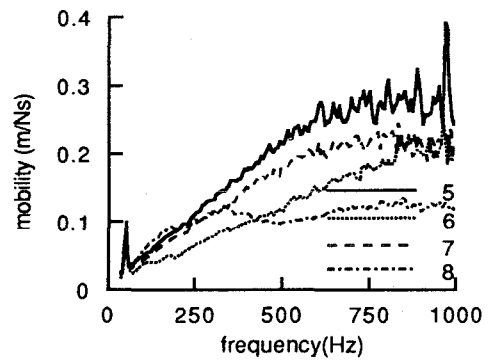

(b) tibial component

(2) mobility spectra of patient B

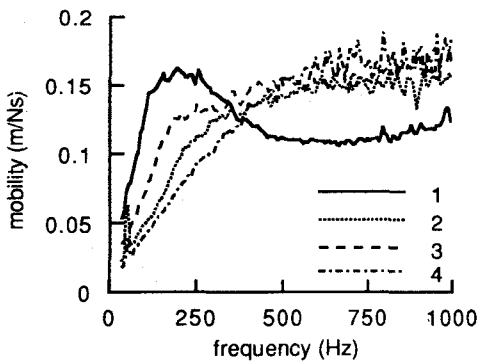

(a) femoral component

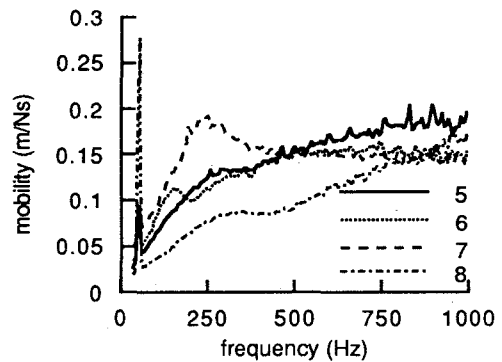

(b) tibial component

(3) mobility spectra of patient C