

# *Transfer Planning of Molten Metals in Steel Works by Decentralized Agent*

Junji KIKUCHI \*, Masami KONISHI and Jun IMAI  
Division of Electronic and  
Information System Engineering  
Graduate School of Natural Science and Technology  
Okayama University  
3-1-1, Tsushima-Naka, Okayama, 700-8530

(Received December 12, 2007)

In steel works, molten metals discharged from blast furnace are put into a pan for transportation called torpedo and transported to steel making factory by a locomotive. In molten metals transportation, it becomes issues to prevent temperature drop of molten metals for stable production of down stream plants to shorten transportation time. Therefore it is necessary to make an appropriate plan for molten metals transfer considering the production and the transportation simultaneously. In this paper, molten metals transfer planning method is proposed including production scheduling. That is, torpedo schedule, transfer request assignment and route plan of locomotives are optimized according to each objective.

## 1 INTRODUCTION

In steel works, molten metals discharged from blast furnace are put into a pan for transportation called torpedo and transported to steel making factory by a locomotive. In molten metals transfer, it becomes important issues to attain the stable production and to shorten transportation time to prevent temperature drop of molten metals. Therefore it is necessary to make an appropriate plan for molten metals transfer with considering the production and the transportation simultaneously. However, because a number of locomotives and torpedoes are used in molten metals transfer system of steel works, the combinatorial number of those destinations and transfer routes and assignments of transfer requests is enlarged. As the result, calculation time to make plan for molten metals transfer increases, and it is difficult to cope with frequent transfer requests from plants. In this paper, molten metals transfer planning method which can treat with the frequent transfer requests is proposed.

About related planning method, optimization method of production scheduling and transportation routing

for semiconductor industry has been proposed.[1] In routing, an autonomous decentralized optimization by agents is proposed in 1999 by an Italian scientist and after that mainly applied to transfer routing problems by plural researchers.[2][3] An example of the application is routing of multi mobile robots in semiconductors manufacturing line.[4] [5]

In this paper, the method is newly applied to the problem of molten metals transfer in steel works. In the problem, it is necessary to determine torpedo scheduling, transfer request assignment and route planning of locomotives for torpedo transfer from one plant to down stream plants. Torpedo schedule is made to minimize the time from first process to last one about each torpedo. Transfer requests are assigned to locomotives to transport torpedoes efficiently and to minimize transportation cost. In route planning, each locomotive is considered as an agent, and the entire plan is cooperatively optimized for each agent repeating an individual optimization of route plan with data exchange. In the following, the structure of molten metals transfer planning system is presented together with its experimental results.

---

\*kikuchi@cntr.elec.okayama-u.ac.jp

## 2 TRANSPORTATION OF MOLTEN METALS

In this paper, molten metal transfer problem in steel works is treated. As shown in Fig. 1, molten metal discharged from blast furnace is transported to steel making factory through preliminary treatment by using locomotives and tens of torpedo cars. Because transfer requests of torpedo are frequently generated from each factory, the torpedo transfer problem becomes complex. Moreover, it is important to shorten the transportation time of a torpedo to prevent temperature drop of molten metal. Therefore, it is required to make efficient plan of hot metal transfer. In this paper, hot metal transfer planning system that can cope with the complex transfer problem is constructed. And the effectiveness of the system is shown through numerical experiments.

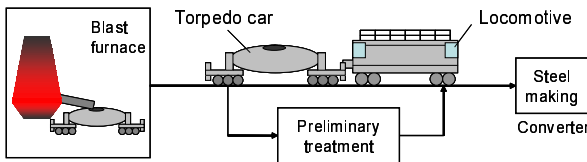

Fig. 1: Molten metal transfer in steel works

Sulfur, phosphorus and slag that are impurities included in molten metals discharged from blast furnaces. Before refining by converter, it is necessary to decrease the element value of sulfur and phosphorus to acceptance element value demanded from converters by preliminary treatment. Necessary pretreatment and processing time are depend on the operation plan of converter. In this paper, it is set that the operation plan of converter has been given beforehand. The flow of

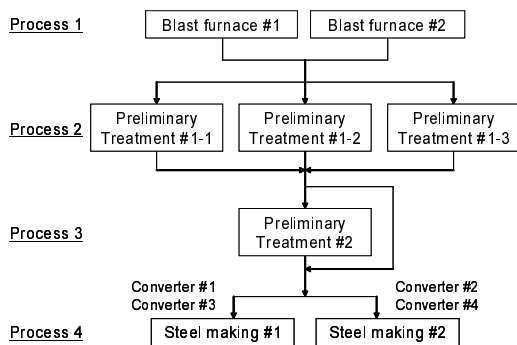

Fig. 2: Molten metal process in steel works

process for molten metals treatment is shown in Fig. 2. Process2 are desulphurization and dephosphorization process. Process3 is deslagging. Process4 is steel making.

Rail track model in steel work is shown in Fig. 3. In this paper, molten metal transfer problem between blast furnaces and steel makings is treated. The rail track consists of rails and numbered nodes connected by them. The speed of locomotives is set at constant. And locomotives can stop or change the direction only on nodes. As a constraint, locomotives should not collide on rails or nodes.

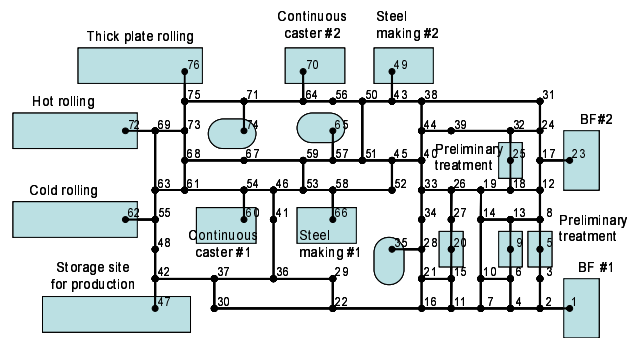

Fig. 3: Rail track model in steel work

The composition of molten metal transfer planning system is shown in Fig. 4. The system is composed of three subsystems. The first is torpedo scheduling subsystem that determines factory where molten metals to be processed. The second is transfer request assignment planning subsystem that determines which locomotive for torpedo transfer. The third is route planning subsystem that decides the routes on which locomotives travel. Here, each locomotive is considered as

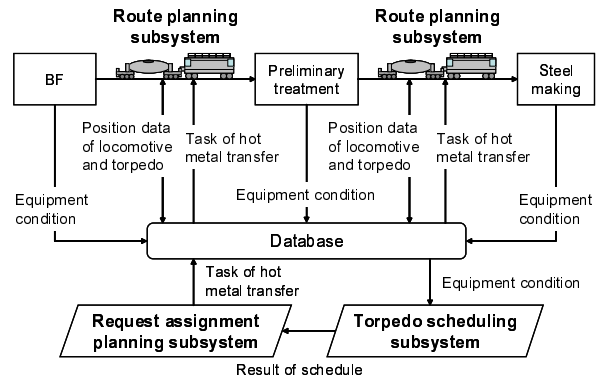

Fig. 4: Molten metal transfer planning system

an agent which has route plan making ability. Necessary information for planning is exchanged between subsystems via database.

### 3 MATHEMATICAL FORMULATION

It is necessary to raise temperature of molten metals before steel making by converter if the temperature decreases below a standard value. In the planning problem for molten metals transfer, transportation of torpedo for a shorter time leads to decrease of energy loss. In this paper, the objective is to decide on torpedo schedule, assignment of transfer request of locomotives and transfer routes of locomotives to shorten the transportation time of torpedo from blast furnace to steel making factory. The problem is formulated by mixed integer programming problem as following.

[Definition of sets]

$P$ : Set of production process

$R$ : Set of torpedoes

$E$ : Set of plants

$V$ : Set of locomotives

$N$ : Set of nodes for rail track model

$N_m$ : Set of nodes which directly connect to node  $\#m$

[Definition of variables]

$$y_{i,j}^k = \begin{cases} 1 & \text{torpedo } \#k \text{ is assigned to plant } \#j \text{ of} \\ & \text{process } \#i. \\ 0 & \text{otherwise} \end{cases}$$

$$z_{i,j}^{k,l} = \begin{cases} 1 & \text{torpedo } \#k \text{ is processed before torpedo } \#l \\ & \text{at plant } \#j \text{ of process } \#i. \\ 0 & \text{otherwise} \end{cases}$$

$$x_{m,n,t}^p = \begin{cases} 1 & \text{locomotive } \#p \text{ travels from node } \#m \text{ to} \\ & \text{node } \#n \text{ in time period } t. \\ 0 & \text{otherwise} \end{cases}$$

$s_{i,j}^k$ : Starting time of torpedo  $\#k$  at plant  $\#j$  at process  $\#i$

$L_{i,j}^k$ : Processing time of torpedo  $\#k$  at plant  $\#j$  at process  $\#i$

$b_{i,j}^k$ : Starting time of transportation for torpedo  $\#k$  from plant  $\#j$  at process  $\#i$

$e_{i,j}^k$ : Ending time of transportation for torpedo  $\#k$  from plant  $\#j$  at process  $\#i$

$T_{i,j}^k$ : Transportation time of torpedo  $\#k$  from plant  $\#j$  at process  $\#i$

[Objective function]

$$\min : \sum_{j \in E} \sum_{k \in R} w^k (s_{4,j}^k - b_{1,j}^k) \quad (1)$$

[Constraints for torpedo scheduling]

$$s_{i,j}^l + M(1 - z_{i,j}^{k,l}) \geq s_{i,j}^k + L_{i,j}^k \quad (2)$$

$$s_{i,j}^k + Mz_{i,j}^{k,l} \geq s_{i,j}^l + L_{i,j}^l \quad (3)$$

$$s_{i,j}^k + L_{i,j}^k \leq b_{i,j}^k \quad (4)$$

$$T_{i,j}^k = e_{i,j}^k - b_{i,j}^k \quad (5)$$

$$e_{i,j}^k \leq s_{i',j'}^k \quad (6)$$

$$z_{i,j}^{k,l} + z_{i,j}^{l,k} = 1 \quad (7)$$

$$\sum_{j \in P} y_{i,j}^k = 1 \quad (8)$$

$$z_{i,j}^{k,l} \leq y_{i,j}^k, \quad z_{i,j}^{k,l} \leq y_{i,j}^l \quad (9)$$

Eqs.(2)(3) indicates the precedence relationship of torpedo processed at each production process. The starting time of torpedo  $\#l$  is later than the ending time of torpedo  $\#k$  if  $z_{i,j}^{k,l} = 1$  and otherwise the starting time of torpedo  $\#k$  is later than the ending time of torpedo  $\#l$ . Eq.(4) indicates that the process ending time of torpedo  $\#k$  at plant  $\#j$  at process  $\#i$  is earlier than the starting time of transportation for torpedo  $\#k$  from plant  $\#j$  at process  $\#i$ . Eq.(5) is the definition of transportation time. Eq.(6) describes constraints between the starting time of process and transportation time indicating that the starting time of torpedo  $\#k$  at plant  $\#j'$  at process  $\#i'$  that immediately follows after plant  $\#j$  at process  $\#i$  is later than the ending time of transportation for torpedo  $\#k$  from plant  $\#j$  at process  $\#i$ . Eq.(7) is assignment constraint of variable  $z$ . Eq.(8) indicates that torpedo is certainly assigned to a equipment at process. Eq.(9) indicates constraints between variable  $y$  and  $z$ .

[Constraints for route planning]

$$\sum_{n \notin N_m} x_{m,n,t}^p = 0 \quad (\forall p, \forall m, \forall t) \quad (10)$$

$$\sum_{n \in N_m} x_{m,n,t}^p \leq 1 \quad (\forall p, \forall i, \forall t) \quad (11)$$

$$\sum_{n \in N_m} x_{m,n,t}^p = \sum_{h \in N_m} x_{m,h,t+1}^p \quad (\forall p, \forall m, \forall t) \quad (12)$$

$$\sum_{n \in N_{S_p}} x_{S_p,n,b_{i,j}^k}^p = 1 \quad (\forall p) \quad (13)$$

$$\sum_{n \in N_{E_p}} x_{G_p,n,e_{i,j}^k}^p = 1 \quad (\forall p) \quad (14)$$

$$\sum_{p \in V} \sum_{n \in N_m} x_{n,m,t}^p \leq 1 \quad (\forall m, \forall t) \quad (15)$$

$$\sum_{p \in V} (x_{m,n,t}^p + x_{n,m,t}^p) \leq 1 \quad (\forall m, \forall n, \forall t) \quad (16)$$

Here,  $S_p$  indicates the start node of locomotive  $\#p$ .  $G_p$  indicates the goal node of locomotive  $\#p$ . Eq.(10) indicates that a locomotive  $\#p$  cannot travel from node  $\#m$  to node  $\#n$  which is not directly connected to node  $\#m$ . Eq.(11) indicates that locomotive  $\#p$  can take only one arc at a same time. Eq.(12) indicates the time continuity constraints of the movement of locomotives. Eqs.(13) and (14) indicates the initial and ending condition of locomotives. Eq.(15) indicates that more than one locomotive cannot travel to a node at a same time. Eq.(20) indicates only one locomotive can travel on the arc at a same time.

## 4 TRANSFER PLANNING METHOD OF MOLTEN METALS

This chapter explains torpedo scheduling subsystem, transfer request assignment subsystem and route planning subsystem that make the plan for molten metals transfer. Then, the entire plan making algorithm composed of three subsystems is described.

### 4.1 Torpedo Scheduling Subsystem

In torpedo scheduling subsystem, SA method is used to optimize the assignment of torpedo to process plant, the starting time and the ending time of process. The calculation method for the starting time of process is explained in Fig. 5. Here, the starting time is calculated under the condition the transportation time of torpedo is constant. The constant is lower bound value of transportation time. The optimization algorithm for torpedo scheduling is described in the following.

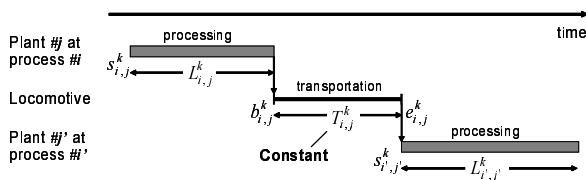

Fig. 5: The calculation method for the starting time of process

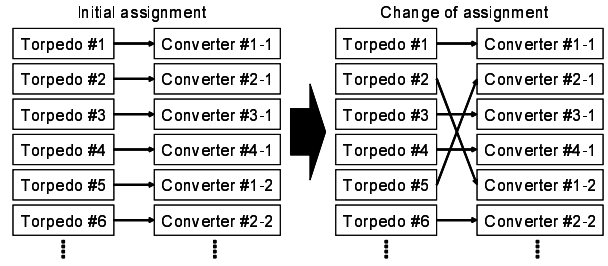

Fig. 6: Change of assignment of torpedo to the operation of converter

#### STEP1 Initial solution making

Torpedoes are assigned to converters in the order of torpedoes receiving molten metals early. Necessary pretreatment and processing time of molten metals in torpedoes are decided. Each torpedo is assigned to the pretreatment equipment with the earliest ending time of process. Next, to fill constraints, the starting time and ending time of process at each equipment are calculated. This is assumed to be a tentative solution.

#### STEP2 Neighborhood solution making

Two torpedoes are selected at random, and the assignment to the operation of converter is exchanged as shown in Fig. 6. Then, the assignment of torpedoes to pretreatment equipments and the starting time and ending time of process are decided.

#### STEP3 Selection of solution

The solution is selected by using SA method. If the neighborhood solution is selected, the solution is preserved as a tentative solution.

#### STEP4 Convergence check

If temperature parameter becomes below a regulated one, the solution with best evaluation from among obtained solutions is output and the algorithm is ended. Otherwise, it returns to STEP2.

### 4.2 Request Assignment Planning Subsystem

A transfer request is generated when the process of molten metals finishes in each plant. The priority chart for transfer request assignment is made according to torpedo scheduling as shown in Fig. 7. In the initial

chart, the requests are ranked in order of the ending time of process in each plant. It is preferable that the locomotive has arrived by the ending time of process to prevent temperature drop of molten metals by standby time. Moreover, it is required to minimize the traveling time of locomotives for minimizing transportation cost. In this paper, the request assignment is optimized so as to minimize the standby time of torpedo in each plant and the traveling time of locomotives. The algorithm for request planning is shown in the following.

**STEP1 Initial assignment of transfer requests**

A transfer request is assigned to the locomotive with the smallest value of evaluation function in Eq. (17) in order of the request that priority is higher. This is assumed to be a tentative solution.

$$f_r^p = t_{\text{final}}^p + D(E_{\text{final}}^p, S_r) \tag{17}$$

Here,  $t_{\text{final}}^p$  indicates that the transportation ending time of previous request assigned to locomotive  $\#p$ .  $E_{\text{final}}^p$  indicates that the node which locomotive  $\#p$  exists when it has ended the previous request.  $S_r$  indicates that the starting node of request  $\#r$ .  $D(E_{\text{final}}^p, S_r)$  indicates that the lower bound value of travel time from ending node of previous request assigned to locomotive  $\#p$  to the starting node of request  $\#r$ .

**STEP2 Reassignment of transfer requests**

A transfer request is selected randomly, then its priority is changed with the request that priority is high or low by one. And transfer requests are assigned to the locomotive with the smallest value of evaluation function in Eq.(17) in order of the request that priority is higher. This is assumed to be a neighborhood solution.

**STEP3 Selection of solution**

The solutions are evaluated by using Eq.(18),

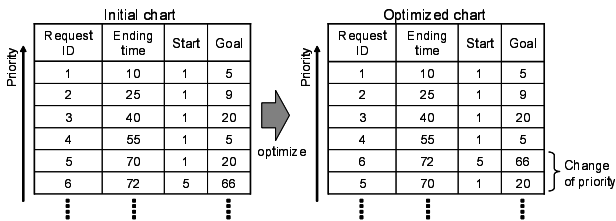

Fig. 7: Priority chart of transfer request for assignment

then if the evaluation value of neighborhood solution is smaller than the one of tentative solution, the neighborhood solution is preserved as a tentative solution.

$$\min : \sum_{r \in J} g_r \tag{18}$$

$$g_r = D(E_{\text{final}}^p, S_r) + \beta \cdot \max\{0, T_r - A_r^p\} \tag{19}$$

Here,  $J$  indicates set of transfer request.  $T_r$  indicates that the ending time of process in relation to request  $\#r$ .  $\beta$  is the weight coefficient.  $A_r^p$  indicates that the time when locomotive  $\#p$  arrives at the starting node of request  $\#r$ .

**STEP4 Convergence check**

If the neighborhood solution is made with regulated frequency, the tentative solution is output as an optimal solution and the algorithm is ended.

**4.3 Route Planning Subsystem**

In route planning subsystem, each locomotive agent has route planning algorithm and creates the route autonomously. Transfer route is created to minimize the objective function that is the total traveling time. Agents optimize the entire route cooperatively with repeating route optimization and route data exchange.

The procedure of torpedo transfer task by locomotive is shown in Fig. 8. First, a locomotive travels from its standby place to the plant that transfer request is generated and connects with the torpedo. Then, the torpedo is transported from the plant to transfer destination and separated. Therefore, it is necessary to make two routes for one transfer task.

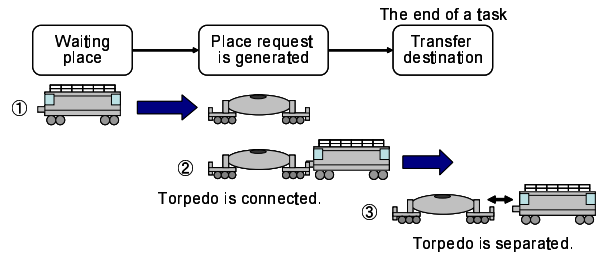

Fig. 8: Processing procedure of torpedo transfer task by locomotive

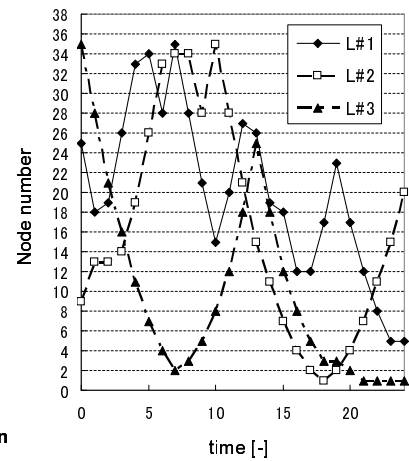
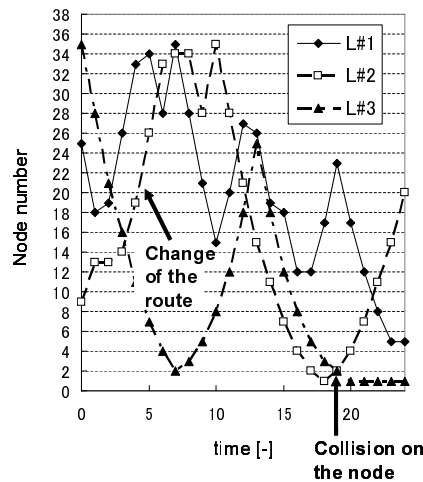
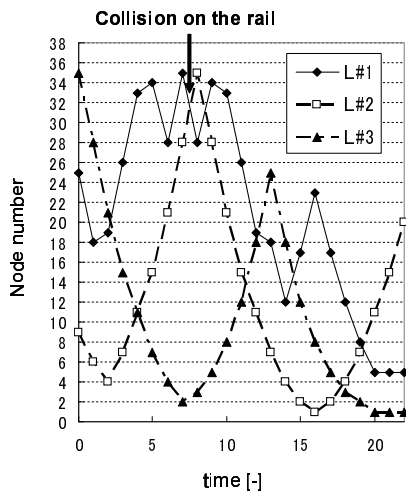

Fig. 9: Result of initial route plan-

Fig. 10: Result of first route re-

Fig. 11: Result of second route re-

### 4.3.1 Algorithm for route plan making

This section explains the algorithm for route plan making of locomotives which have plural destinations. In this algorithm, first, each locomotive makes routes without considering other locomotives. Then, only the locomotives which collide with other locomotives re-plan the transfer route about the area where the collision has been caused and about the area after that. Moreover, the route was efficiently made by applying Dijkstra method to the shortest route searching. Details of the algorithm for transfer route planning are shown as follows.

#### STEP1 Initial route planning

Each locomotive makes the shortest route without considering the collision with other locomotives.

#### STEP2 Data exchange

The tentative route plans are exchanged between all locomotives.

#### STEP3 Ending check of algorithm

If the collision has not occurred between all locomotives in the obtained result by data exchange, the algorithm is ended.

#### STEP4 The areas where locomotive collides are extracted.

The area where locomotive collides is extracted by using the obtained result.

#### STEP5 Transfer route making about the area where locomotive collides

Table. 1: Initial and goal position of each locomotive

locomotive	initial	first	second	third
#1	25	35	23	5
#2	9	35	1	20
#3	35	5	25	1

Each locomotive makes the route about the area where the collision has occurred by using decentralized agent method. Here, the locomotive which has not collided does not replan.

#### STEP6 Transfer route making about other areas

Each locomotive makes the shortest routes about areas in the back of the area where the collision has occurred. And it returns to STEP2.

### 4.3.2 Example of route planning

In this section, the algorithm for route planning is verified through numerical experiments about the problem which three locomotives process transfer requests. The initial and goal nodes of each locomotive are set as shown in Table 1. The numbers in table are node numbers in rail track model as shown in Fig. 3. The results of numerical experiments are shown in the following.

In initial route planning, the shortest routes are made without considering routes of other locomotives. As a result, locomotive #1 and locomotive #2 collide on the rail between node #28 and node #35 between seven time

period and eight time period as shown in Fig. 9. The collision area of locomotive #1 is section II and the one of locomotive #2 is area I as shown in Fig. 12. The upper numbers on time charts indicate time period and the below numbers indicate node numbers. Therefore, the route in area I of locomotive #1 is preserved without modification. Locomotive #1 and locomotive #2 remake the routes about only the area which collision has occurred by using decentralized agent method. After that, the shortest routes are made about areas in the back of the area where the collision has occurred.

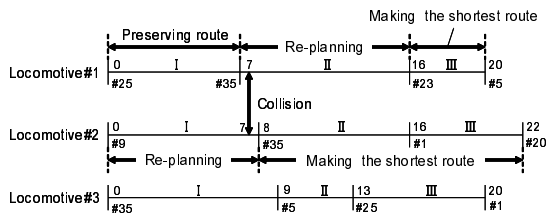

Fig. 12: Time chart by initial route planning

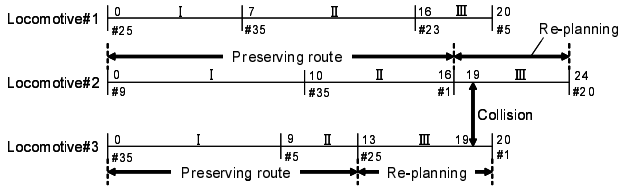

Fig. 13: Time chart by first route re-planning

As shown in Fig. 10, the route plan remaking about the area which locomotives collide results in collision avoidance at the position. However, the collision has occurred between locomotive #2 and locomotive #3 at nineteen time period by making shortest routes about the areas in the back of the area where the collision has occurred. Therefore, the routes until area II of each locomotive are preserved and each locomotive remakes the route plan about area III as shown in Fig. 13.

Finally, it is confirmed that the route plan without collision between locomotives is made as shown in Fig. 11.

#### 4.4 Algorithm for Entire Plan

This section explains algorithm of entire plan for molten metals transfer. As shown in Fig. 14, the en-

tire plan is made by three subsystems. Details of the algorithm is described in the following.

##### STEP1 Torpedo scheduling

Torpedo schedule is made under the condition that transportation time of torpedoes between plants is constant.

##### STEP2 Transfer request assignment

Transfer requests of torpedoes are assigned to locomotives by using scheduling result.

##### STEP3 Transfer route planning

The transfer route plans of locomotives are made by using the result of transfer request assignment.

##### STEP4 Feasible check

If the obtained schedule is feasible, the algorithm is ended. Otherwise, it goes to STEP5.

##### STEP5 Modification of torpedo scheduling

The starting time of process is modified by using the result of route planning. And it returns to STEP3.

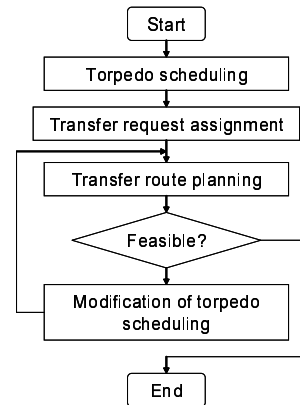

Fig. 14: Algorithm for molten metals transfer planning

## 5 NUMERICAL EXPERIMENT

In this chapter, the effectiveness of the proposed planning system is demonstrated through numerical experiments. The problem that sixteen torpedoes are transported by three locomotives is solved as an example. The results and conditions of numerical experiments are shown in the following.

### 5.1 Experimental Condition

The problem that sixteen torpedoes are transported by using three locomotives is treated as an example. Processing time required at each process are set as shown in Table 2. Moreover, necessary pretreatment process for converter operation is shown in Table 3

Table. 2: Processing time of each process

Process	Plant	Processing time
1	Blast furnace	10
2-A	Pretreatment 1.1-1.3	45
2-B	Pretreatment 1.1-1.3	25
3	Pretreatment 2	10
4	Steel making	60

Table. 3: Necessary pretreatment process for converter operation

Operation ID	1	2	3	4
Converter #1	2-A	2-B, 3	2-A	2-A, 3
Converter #2	2-B, 3	2-A	2-A, 3	2-B, 3
Converter #3	2-B	2-A, 3	2-A, 3	2-B
Converter #4	2-A, 3	2-A, 3	2-B	2-A, 3

### 5.2 Result of Molten Metals Transfer Planning

The transition of objective function by torpedo scheduling optimization is shown in Fig. 15. It is confirmed that the solution converges.

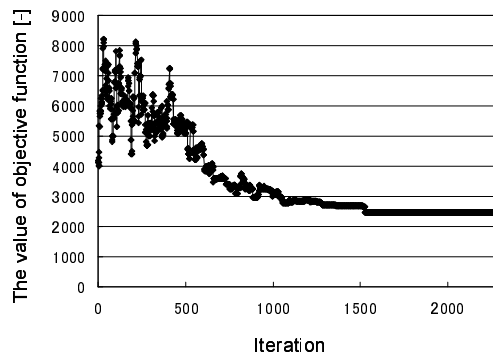

Fig. 15: Transition of objective function by torpedo scheduling optimization

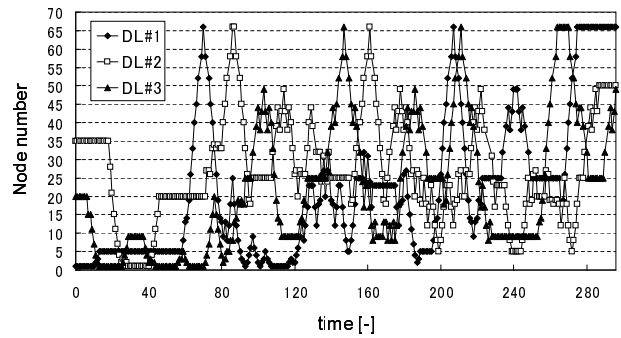

Fig. 17: A time chart of the transfer routing result

The Gantt chart of torpedo schedule is shown in Fig. 16. The number in the belt shows the identity of torpedoes. For example, torpedo #1 is transported from blast furnace #1 to pretreatment #1-1 by locomotive #1. After processed in the pretreatment #1, the torpedo is transported to steel making factory #1 by locomotive #1. From this chart, it is confirmed that a feasible schedule is obtained. The lower side of the Gantt chart indicates locomotives are under the condition in standby, movement to the request generated place and torpedo transportation.

The result of transfer route planning is shown in Fig. 17. This shows a timing chart of obtained route plan that transverse axis is time and vertical axis is node number that locomotives exist. If there are a number of plots on the same node at the same time, that means collision on the node between locomotives. If the plots intersect symmetrically, that means collision on the rail. From this chart, it is confirmed that the route plan that there is no collision between locomotives is made. Moreover, the total traveling time of each locomotive is 159, 194 and 181.

### 5.3 Comparison with Conventional Method

In this section, the proposed and the conventional method about transfer request assignment are compared. The conventional method uses a rule that evaluation function in Eq.(17) is calculated and the request is assigned to the locomotive with the smallest value. The results of comparison with proposed and conventional method are shown in Table 4. Single travel time of locomotives in the proposed method greatly decreases compared with the conventional one. Travel



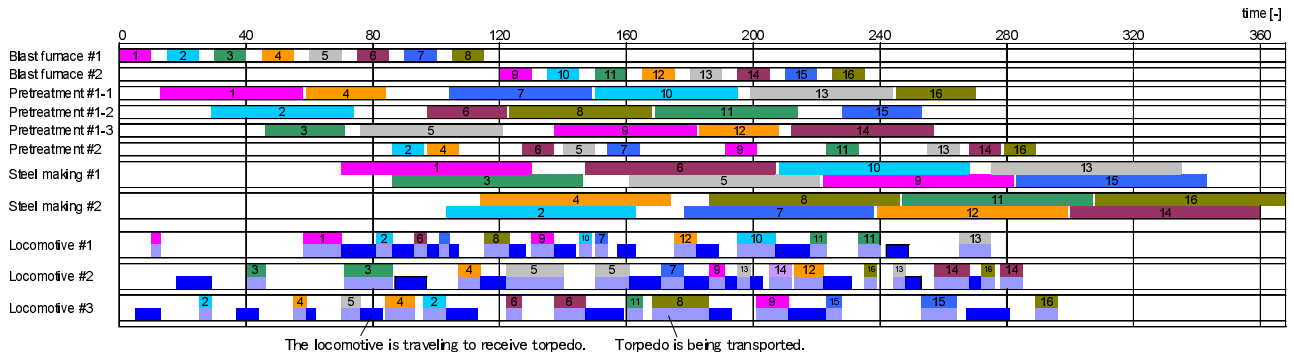

Fig. 16: Gantt chart of optimized torpedo schedule

time of locomotives with torpedo is almost same value. In the proposed method, the total travel time of locomotives can be reduced by about 9.8%. The value of objective function in the proposed method has become small because the standby time of torpedoes is reduced. Moreover, CPU time has become almost equal because the CPU time for assignment optimization is to be short enough compared with the time for other optimization.

Table. 4: Comparison with proposed and conventional method(Pentium IV 3.4GHz, 1024MB Memory is used)

	Proposed method	Conventional method
Single travel time [-]	223	288
Travel time with torpedo [-]	311	304
Sum of travel time [-]	534	592
Objective function [-]	3321	3397
CPU time [sec]	1293	1226

## 6 CONCLUSION

In this paper, molten metals transfer planning system is proposed which consists of torpedo scheduling subsystem, transfer request for assignment planning subsystem and route planning subsystem. A feasible schedule is obtained in a allowable computing time in three subsystems dividing the large-scale problem. Through numerical experiments, it is demonstrated to be able to cope with frequent transfer requests by applying decentralized agent method to route planning of

locomotives . Optimizing assignment priority of transfer request makes it possible to reduce travel time of locomotives about 9.8%.

## REFERENCES

- [1] Takahiro Furusho, Tatsushi Nishi, Masami Konishi and Jun Imai:2006 International Symposium on Flexible Automation, (2006), 389-396
- [2] M. Dorigo and A. Colomi:IEEE Transacitons on SMC, 26-1(1996), 29-41
- [3] H. Kawamura, M. Yamamoto, K. Suzuki and A. Ohuchi:Intelligent Autonomous Systems, IOS Press, (1998), 587-594
- [4] T. Nishi, K. Sotobayashi and M. Konishi:JSME International Journal C, 46-1(2003), 18-23
- [5] Masakazu Ando, Tatsushi Nishi, Masami Konishi and Jun Imai:2003 IEEE International Symposium on Computational Intelligence in Robotics and Automation (2003), 718-723
- [6] Al-Sehaim Sulaiman, M. Konishi, K. Nose: Preprint of the academic conference of the Japan society for production management, (2004), 107-110

## Appendix

### A OBJECTIVE FUNCTION OF ROUTE PLANNING

A binary variable  $\delta_{p,t} \in \{0, 1\}$  denoting whether locomotive  $\#p$  arrives at goal node in time period  $t$  is defined.

$$\sum_{m \in N_{G_p}} x_{m,G_p,t}^p \leq M(1 - \delta_{p,t}) \quad (\forall p, \forall t) \quad (20)$$

$$\sum_{m \in N_{G_p}} x_{m,G_p,t}^p \geq 1 - \delta_{p,t} \quad (\forall p, \forall t) \quad (21)$$

Here,  $G_p$  is the goal node of locomotive  $\#p$ ,  $M(= 1)$  is the upper bound value of left side portion of Eq.(20). Moreover, the following expression is added to constraint because the locomotive that arrived at the goal node once stops in the place.

$$-\delta_{p,t} + \delta_{p,t+1} \leq 0 \quad (\forall p, \forall t) \quad (22)$$

Thus, transfer route planning object can be formulated as follows.

$$\min \sum_p \sum_t \delta_{p,t} \quad (23)$$

### B ALGORITHM FOR ROUTE PLANNING BY DECENTRALIZED AGENT METHOD

The algorithm for transfer route planning is shown in Fig. 18. In this algorithm, locomotive agents optimize the entire route plan while repeating route search and data exchange. In the data exchange between agents, the first routs that individual agent made are exchanged through data base. Then, route search is repeated until the route plan becomes feasible and the value of objective function converges. Pheromone information that identifies each agent is scattered on the first route, and the secondary route is made by referring to this pheromone information. Details of the algorithm are shown in the following.

#### STEP1 Preparation of initial data

The locomotive that receives transfer request obtains the start node and the goal node. Moreover, temperature parameter is initialized as  $T_b = T_0$ .

#### STEP2 Creation of a first route

Each locomotive randomly creates its first route from start node to goal node without considering the routes of other locomotives.

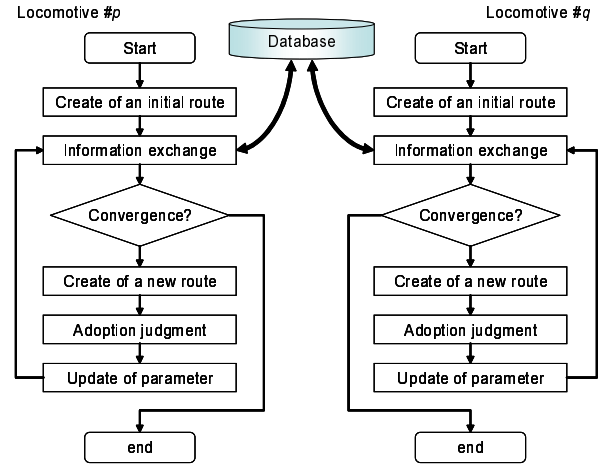

Fig. 18: Algorithm for route planning

#### STEP3 Update of pheromone information

Each locomotive accesses database and updates the value of pheromone information using Eq.(24), (25).

$$ph_{m,t}^p = (1 - \rho)ph_{m,t}^p + W \sum_{n \in N_m} x_{n,m,t}^{p(1)} \quad (24)$$

$$(\forall m \in N)$$

$$ph_{u,t}^p = (1 - \rho)ph_{u,t}^p \quad (\forall m \in N, \forall u \notin N_m) \quad (25)$$

Where,  $ph_{m,t}^p$  is the amount of pheromone sprinkling on node  $m$  at time period  $t$ .  $W$  is the sprinkle amount of pheromone and  $\rho$  is the evaporation factor.

#### STEP4 Information exchange

Each locomotives writes its first route information in database, and loads pheromone and first route information of other locomotives at the same time.

#### STEP5 Evaluation of a first route

The first route solution is evaluated using Eq.(26).

$$I_p^{(1)} = \sum_t \delta_{p,t}^{(1)} + \sum_{q \neq p} \alpha_{p,q}(r) \cdot C_{p,q}^{(1)} \quad (26)$$

Where,  $I_p^{(1)}$  represents the value of objective function for locomotive  $\#p$  by first solution.  $\alpha_{p,q}(r)$  is the weight of penalty function to collision between locomotive  $\#p$  and locomotive  $\#q$  at  $r$ -th iteration and  $C_{p,q}^{(1)}$  is collision number of times between locomotive  $\#p$  and locomotive  $\#q$  on the first route.

**STEP6 Convergence check**

The algorithm is terminated if the following convergence criteria are satisfied.

- All locomotives don't cause collision.
- Route solution is not updated with regulated frequency.

**STEP7 Creation of a secondary route**

- (a) Each locomotive randomly creates a candidate of the node  $\#m$  traveling in time period  $(t + h_{n,m})$  from the node in time period  $t$ .  $h_{n,m}$  is travel time from node  $\#n$  to node  $\#m$ .
- (b) Each locomotive obtains pheromone information on the candidate node and calculate  $\Delta ph$  using the Eq.(27).

$$\Delta ph = ph_{m,t+h_{n,m}}^p - \sum_{p' \neq p} ph_{m,t+h_{n,m}}^{p'} \quad (\forall m \in N_n) \quad (27)$$

- (c) If  $\Delta ph$  satisfies the following Eq.(28), the candidate node is accepted, and otherwise rejected and return to (a).

$$d \leq P \quad (28)$$

$$P = \begin{cases} 1 & : \Delta ph \geq 0 \\ \exp(\Delta ph/T_a) & : \Delta ph < 0 \end{cases} \quad (29)$$

$d$  is a random number with probability of uniform distribution on the interval  $[0,1]$ .

- (d) If the candidate node does not reach the goal node, the time is updated such as  $t \leftarrow t + h_{n,m}$  then return to (a).

**STEP8 Evaluation of a secondary route**

The secondary route solution is evaluated using Eq.(30).

$$I_p^{(2)} = \sum_t \delta_{p,t}^{(2)} + \sum_{q \neq p} \alpha_{p,q}(r) \cdot C_{p,q}^{(2)} \quad (30)$$

Where,  $I_p^{(2)}$  represents the value of objective function for locomotive  $\#k$  by secondary solution.  $C_{p,q}^{(2)}$  is collision number of times between locomotive  $\#p$  on the secondary route and locomotive  $\#q$  on the first route.

**STEP9 Adoption criteria of the secondary route**

The different value of objective function  $\Delta I_p = I_p^{(1)} - I_p^{(2)}$  is calculated and the secondary route is adopted and it is updated as the first route if the secondary solution satisfies the following Eq.(31).

$$d \leq Q \quad (31)$$

$$Q = \begin{cases} 1 & : \Delta I_p \geq 0 \\ \exp(\Delta I_p/T_b) & : \Delta I_p < 0 \end{cases} \quad (32)$$

**STEP10 Update of penalty weight**

The weight of penalty function for only locomotive causing collision is updated using Eq.(33).

$$\alpha_{p,q}(r+1) = \alpha_{p,q}(r) + \Delta\alpha \sum_{q \neq p} C_{p,q}^{(2)} \quad (33)$$

Where,  $\Delta\alpha$  is a constant number. If secondary route is created on  $r_s$  times at the same temperature parameter, the parameter is updated using Eq.(34) and return to STEP3.

$$T_b \leftarrow \gamma \cdot T_b \quad (34)$$

Where,  $\gamma$  is a annealing ratio.

Parameters for the algorithm are given as shown in Table 5. These parameters influence the accuracy and convergence of solution. Here, these are set in appropriate value experimentally from past research.

Table 5: Parameters in algorithm

$W$	$\rho$	$T_a$	$T_0$	$\Delta\alpha$	$\gamma$
6	0.3	20	15	0.8	0.9